

DATASHEET RFSGXX Specification v2.64

Microwave Signal Generator from 9 kHz to 26.5 GHz



DEFINITIONS

- The specifications in the following pages describe the warranted performance of the instrument for 23 ± 5 °C after a 30-minute warm-up period (unless otherwise stated).

Min/Max: Parameter range that is guaranteed by product design, and/or production tested. Warranted performance specifications include guard-bands to account for the expected statistical performance distribution, measurement uncertainties, and changes in performance due to environmental conditions.

Typical: Expected mean values, not warranted performance.

INTRODUCTION

- **Very compact, portable analogue signal generator models with a range from 9 kHz (with option 9K) up to 26.5 GHz.**

The RFSGXX is a series of low-noise and fast-switching microwave signal generators covering a continuous frequency ranges from as low as 100 kHz up to 12, 20, and 26 GHz, respectively, with a 0.001 Hz resolution.

The RFSGXX provide an accurately levelled output power range and high spurious suppression. Advanced frequency synthesis with fractional-N divider makes for low SSB phase noise and micro-Hz resolution.

Available Options:

- **Option HP** delivers higher maximum output power to a level up to +27 dBm.
- **Option PE3** is an optional power level extension to accurately level below -90 dBm.
- **Option FS** substantially enhances the switching speed
- **Option NM** removes all built-in modulation capabilities if not needed (RFSG20G, RFSG26G only)
- **Option B3** adds an internal rechargeable battery module
- **Option 9K** low frequency extension down to 9 kHz (RFSG20G, RFSG12G only)
- **Option 1URM** modifies form-factor to a 19" rack-mountable 1HU enclosure
- **Option LH** Desktop housing with color touch display

The standard RFSGXX includes amplitude modulation (AM), DC-coupled, low distortion wideband frequency modulation (FM), PM, FSK and PSK, frequency chirp, and fast pulse modulation with internal pulse train generator. Three internal modulations sources are available. All modulation modes of the RFSGXX can be combined. This allows the generation of complex modulation signals for modern communication and location systems. The combination of pulse modulation and FM simulates Doppler effects or chirp signals. Simultaneous AM and pulse modulation provide the types of signal occurring in pulse radar applications with rotating antenna. The combination of FM and AM can be used to check fading effects of FM receivers.

All RFSGXX allow fast analog and digital sweeps including flexible list sweeps, where frequency, power and dwell times can be set individually. A flexible triggering capability simplifies synchronization within test environments.

All RFSGXX operate with an ultra-stable temperature compensated 100 MHz reference (OCXO) to ensure minimal drift, and can be phase-locked to any stable external reference in a range from 1 to 250 MHz. Additionally, optimum phase synchronous signals can be achieved by bypassing internal and feeding a 100 MHz signal directly as reference.

The RFSGXX support various standard interfaces such as USB-TMC, LAN, and GPIB.

Applications for the RFSGXX include

- R&D low noise microwave source
- Production testing (industry-leading switching times; high dynamic range)
- Service and maintenance (battery operation)
- Signal simulation (Radar, WiMax, UWB)
- Aerospace & Defence (Pulse modulator, Chirps)

SPECIFICATIONS

PARAMETER	MIN	TYPICAL	MAX	NOTE
Frequency range	100 kHz 100 kHz 100 kHz 9 kHz		12.0 GHz 20.0 GHz 26.0 GHz	RFSG12G RFSG20G, settable to 20.5 GHz RFSG26G, settable to 30 GHz Option 9 kHz
resolution		0.001 Hz		
Phase resolution		0.1 deg		
Frequency / Amplitude settling time		200 μ s	300 μ s 30 μ s	option FS
SSB Phase noise standard				
500 MHz				
10 Hz offset		-74 dBc/Hz		
1kHz offset		-126 dBc/Hz		
100 kHz offset		-137 dBc/Hz		
4 GHz				
10 Hz offset		-68 dBc/Hz		
1kHz offset		-108 dBc/Hz		
100 kHz offset		-119 dBc/Hz		
20 GHz				
10 Hz offset		-51 dBc/Hz		
1kHz offset		- 91 dBc/Hz		
100 kHz offset		- 104 dBc/Hz		
Wideband noise		-150 dBc/ Hz		
Amplitude Noise at 10 GHz		-130 dBc/Hz -140 dBm		Pout=+10 dBm, 100 kHz offset noise floor
Output power				Check maximum output power plots on page 10
Standard				
100 kHz to fmax	-20 dBm		+15 dBm	
Option PE3 only				
100 kHz to fmax	-90 dBm		+12 dBm	
Option HP only				
	-20 dBm		+18 dBm	< 200 MHz
	-20 dBm		+25 dBm	0.2 to 5.5 GHz
	-20 dBm		+23 dBm	5.5 to 16 GHz, see plot
	-20 dBm		+20 dBm	16- 24 GHz, see plot
Options HP and PE3				
	-20 dBm		18 dBm	< 200 MHz
	-90 dBm		+22 dBm	0.2 to 10 GHz
	-90 dBm		+20 dBm	10 to 16 GHz
	-90 dBm		+18 dBm	16 to 20 GHz
	-90 dBm		+15 dBm	20 to 24 GHz
	-90 dBm		+12 dBm	> 24 GHz
Level resolution		0.01 dB		
Level uncertainty, ALC on		0.3 dB 0.6 dB 3.0 dB	1.0 dB 1.5 dB 3.0 dB	-15 to +15 dBm -65 dBm to -15 dBm, option PE3 < -65 dBm, f<10 GHz option PE3 < -65 dBm, f>10 GHz option PE3

		1.0 dB	3.0 dB	>	15 dBm to Pmax, option HP
Temperature effects		0.015 dB/ °C			0 to 45 °C
User flatness correction		up to 2000 points			
Output impedance		50 Ω			
VSWR		1.5		>	< 20 GHz 20 GHz
		2.0			
Reverse Power Protection					
DC Voltage			±15 V		
RF power			30 dBm		
Spectral purity at + 5 dBm					
Output harmonics		-40 dBc	-30 dBc		See plot
Sub-harmonics		-75 dBc -50 dBc	-65 dBc -40 dBc	>	< 20 GHz 20 GHz
Non-harmonic spurious					CW +10 dBm, > 3 kHz offset
< 312 MHz		-80 dBc	-66 dBc		
> 312 to 625 MHz		-75 dBc	-70 dBc		
> 625 MHz to 1.5 GHz		-75 dBc	-65 dBc		
> 1.5 GHz to 2.5 GHz		-70 dBc	-65 dBc		
> 2.5 GHz to 5 GHz		-65 dBc	-60 dBc		
> 5 GHz to 10 GHz		-60 dBc	-55 dBc		
> 10 GHz to 20 GHz		-55 dBc	-50 dBc		
> 20 GHz		-50 dBc	-45 dBc		
Residual FM @ 10 GHz		15 Hz			0.3 kHz to 3 kHz, weighted (ITU-T), RMS
Residual AM @ 10 GHz		0.02 %			RMS value (0.01 kHz to 15 kHz)



Sweeping Capability

Sweeps can be performed with combined internal or external AM/FM/PM/pulse modulation running. With modulation enabled, the minimum step time increases to 2 ms.

PARAMETER	MIN	TYPICAL	MAX	NOTE
Digital power / frequency / list sweeps				
Sweep type: linear, logarithmic, random				
Step time (τ_{step})	400 μ s 40 μ s		19998 s	Option FS
Dwell time (τ_{val})	10 μ s		9999 s	
Off-time (incl. transient time) (t_{off})	0		9999 s	
Transient time (τ_{inv})			270 μ s 30 μ s	Option FS
Timing delay (τ_{de})		2 to 10 μ s 50 ns		Option FS
Time resolution		0.1 μ s 5 ns		Option FS
Timing accuracy per point		3 μ s 5 ns		Option FS

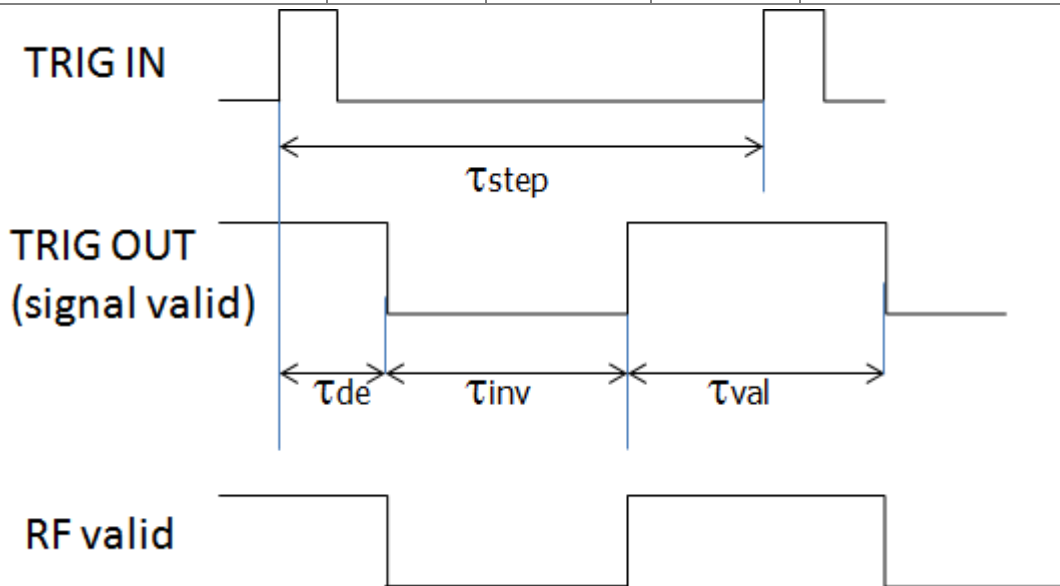

Frequency Chirps

(linear ramp, up/down)

Bandwidth	10 %			of carrier frequency
Dwell time (t_{dwell})	10 ns		10000 μ s	
Slope			100 MHz / μ s	
Number of frequencies			65'000	



Reference Frequency

REF IN input and REF OUT output are at rear panel

PARAMETER	MIN	TYPICAL	MAX	NOTE
Internal reference frequency		100 MHz		
Initial accuracy			±40 ppb	calibrated at 23 ± 3 °C at time of calibration, user adjustable
Temperature stability (0 to 50 degC)			±100 ppb	
Aging 1 st year		0.5 ppm		
Aging per day (after 30days operations)			5 ppb	
Warm-Up time		5 min		
Output of internal reference		10 MHz 10/100 MHz		
Output power		0 dBm		
Output impedance		50 Ω		
Bypass Internal reference Input	100 MHz, -5 to +10 dBm			High phase synchronous mode
Phase Lock to External Reference External Input Range	1 MHz		250 MHz	User programmable
Reference input level	-5 dBm	0 dBm	+13 dBm	
Lock Range			±1.5 ppm	
Reference input impedance		50 Ω		



Multi-Purpose Output (FUNC OUT)

Output is FUNC OUT at rear panel

PARAMETER	MIN	TYPICAL	MAX	NOTE
MULTIFUNCTION GENERATOR				
sine, triangle, square wave				
Frequency range	1 Hz 1 Hz		3 MHz 1 MHz 50 kHz	sine triangle square
Frequency resolution		0.1 Hz		
Output voltage amplitude peak-peak	10 mV	5V	2 V	Sine, triangle Square (CMOS output)
Harmonic Distortion		1 %		< 100 kHz, 1 Vpp
Output impedance		50 Ω CMOS		Sine, triangle square wave
VIDEO OUTPUT (of internal pulse modulator)				
Output		CMOS		
Period	30 ns		50 s	
Pulse Width	15 ns		50 s	
RF delay		10 ns		
TRIGGER OUT Synchronization mode for multiple sources				
Modes	Trigger on sweep start Trigger on each point Signal Valid			Option FS

Trigger (TRIG IN)

Input is TRIG IN at rear panel

PARAMETER	MIN	TYPICAL	MAX	NOTE
Trigger Types	Continuous, single, gated, gated direction			
Trigger Source	RF key, external, bus (GPIO, LAN, USB)			
Trigger Modes	Continuous free run, trigger and run, reset and run			
Trigger latency		2 μ s 5 ns		Option FS
Trigger uncertainty		5 μ s 10 ns		Option FS
External Trigger delay	50 μ s 50 ns		40 s 10 s	programmable Option FS
External Delay Resolution		15 ns 10 ns		Option FS
Trigger Modulo	1		255	Execute only on Nth trigger event
Trigger Polarity	Rising, falling			

Trigger Output (TRIG OUT)

see Multi-Purpose Output (FUNC OUT)

Modulation Capabilities (not with option NM)

Combination of AM/PM/FM/PULSE are possible. See user manual for more details.

PARAMETER	MIN	TYPICAL	MAX	NOTE
Multifunction Generator				
sine, triangle, square wave				
Output is FUNC OUT at rear panel				
Frequency range	10 Hz 10 Hz		3 MHz 1 MHz 50 kHz	sine triangle square
Frequency resolution		0.1 Hz		
Output voltage amplitude peak-peak	10 mV	5V	2 V	Sine, triangle Square (CMOS output)
Harmonic Distortion		1 %		< 100 kHz, 1 Vpp
Output impedance		50 Ω CMOS		Sine, triangle square wave
Pulse Modulation				
On/off ratio		75 dB (typical)		at +10 dBm
Repetition frequency	DC		10 MHz	
Pulse width	30 ns 500 ns		5 s 5 s	ALC hold ALC on
Pulse rise/fall time		7 ns		
Duty cycle	0.05 %		99.95 %	
Pulse resolution		15 ns		

Polarity		selectable		
External input amplitude		1 V TTL		AC DC
Delay (to RF)		20 ns	40 ns	
Pulse Pattern Modulation				Using internal pattern generator at +10 dBm
On/off ratio		75 dB		
Pulse bit width	30 ns 500 ns			ALC hold ALC on
Pulse rise/fall time		30 ns 7 ns		<5 GHz >5 GHz
Programmable pattern length	2		4192	
Duty cycle	0.05 %		99.95 %	
Pulse bit resolution		30 ns 10 ns		Option FS
Polarity		selectable		
Frequency Modulation				
Maximum Frequency deviation (peak)	>	0.05·f N · 200 MHz		< 1.25 GHz 1.25 GHz to 2.5 GHz (N=0.125) 2.5 GHz to 5 GHz (N=0.25) 5 GHz to 10 GHz (N=0.5) > 10 GHz to 20 GHz (N=1)
Deviation accuracy				
< 100 kHz rate		0.5 %	2 %	
> 100 kHz rate		2 %	5 %	
Distortion		< 1 %		1 kHz rate, 50 kHz deviation
Modulation rate	DC		800 kHz	> -3dB frequency response
Modulation waveforms		Sine, triangle, FSK		
External input sensitivity				
AC coupled		0 to N · 200 MHz / V		adjustable for ±1 V range discr. values; ±5 V range
DC coupled		0 to N · 100 MHz / V		
Total harmonic distortion		< 1%		1 kHz rate & N · 1 MHz deviation
Phase Modulation				
Phase deviation (peak)	0		N·300 rad	
Modulation rate	DC		800 kHz	> -3dB frequency response Max. phase deviation degrades above 20 kHz modulation rate
Modulation waveforms		Sine, triangle, FSK		
External Input sensitivity		Settable 0.1 rad/V to 360 rad/V		
Total harmonic distortion		< 1%		1 kHz rate & N x 100 rad deviation
Amplitude Modulation				
Modulation rate	0.1 Hz		50 kHz	
Modulation waveforms		Sine, triangle, square		
Modulation depth	0 %		90 %	settable
Distortion (sine wave)		2 %		at 60% modulation depth

PERFORMANCE CURVES

Typical performance curves Phase Noise Performance (1 Hz to 100 MHz offset) at different frequencies

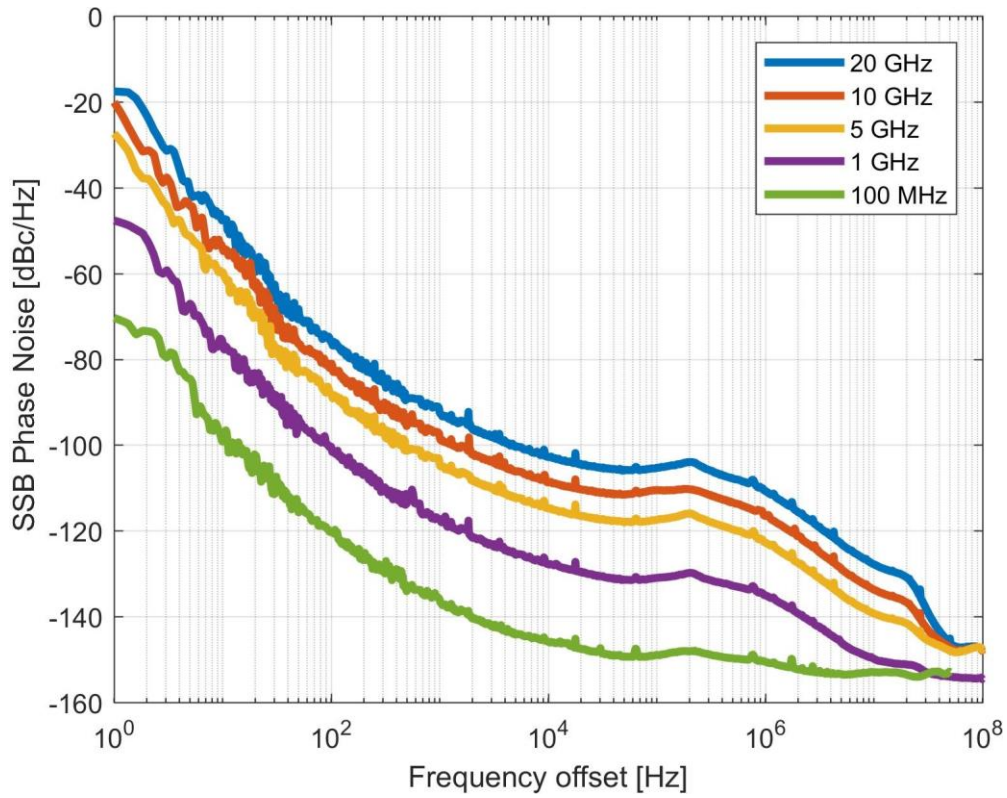

Typical Switching transient from 12 GHz to 14 GHz step

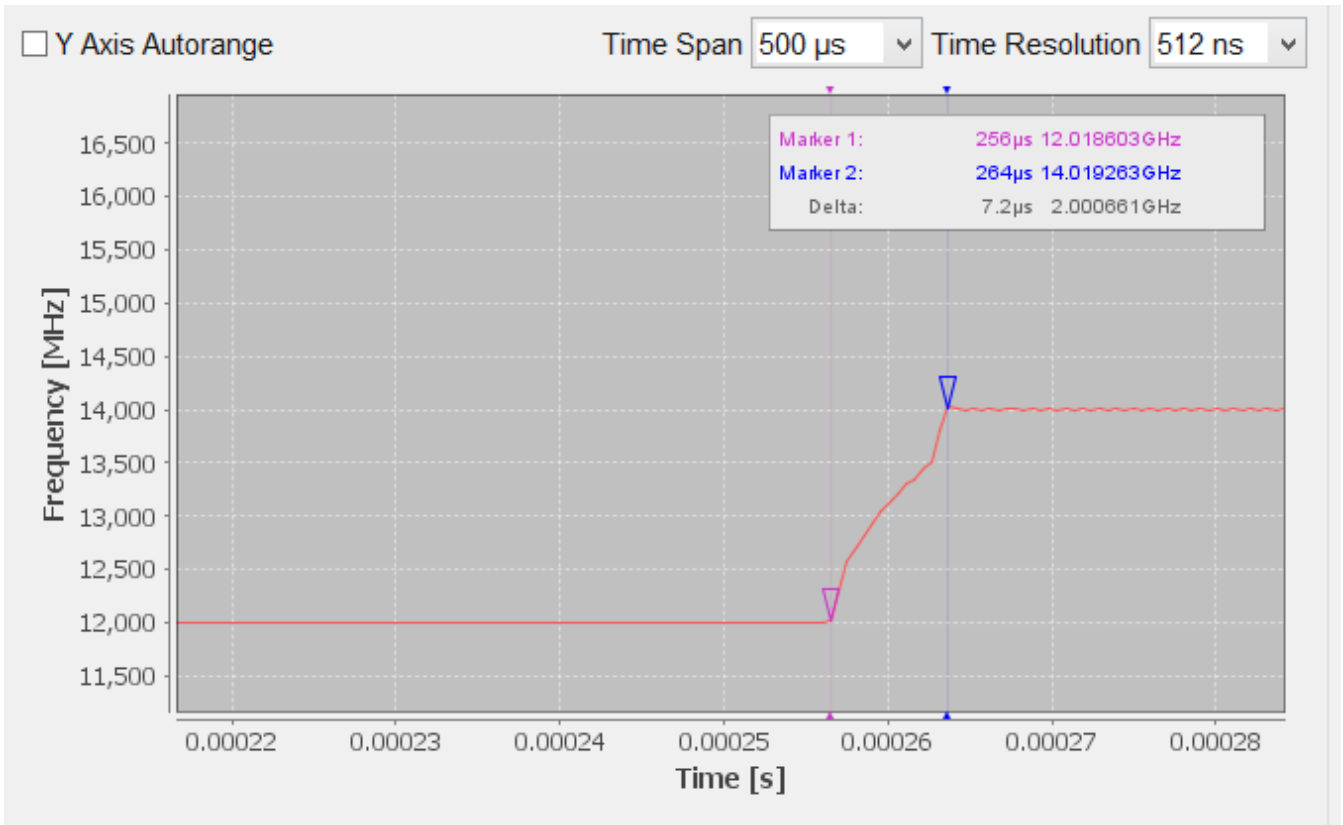

 Typical Frequency Response 0 to 20 GHz at -20, 0, and +20 dBm

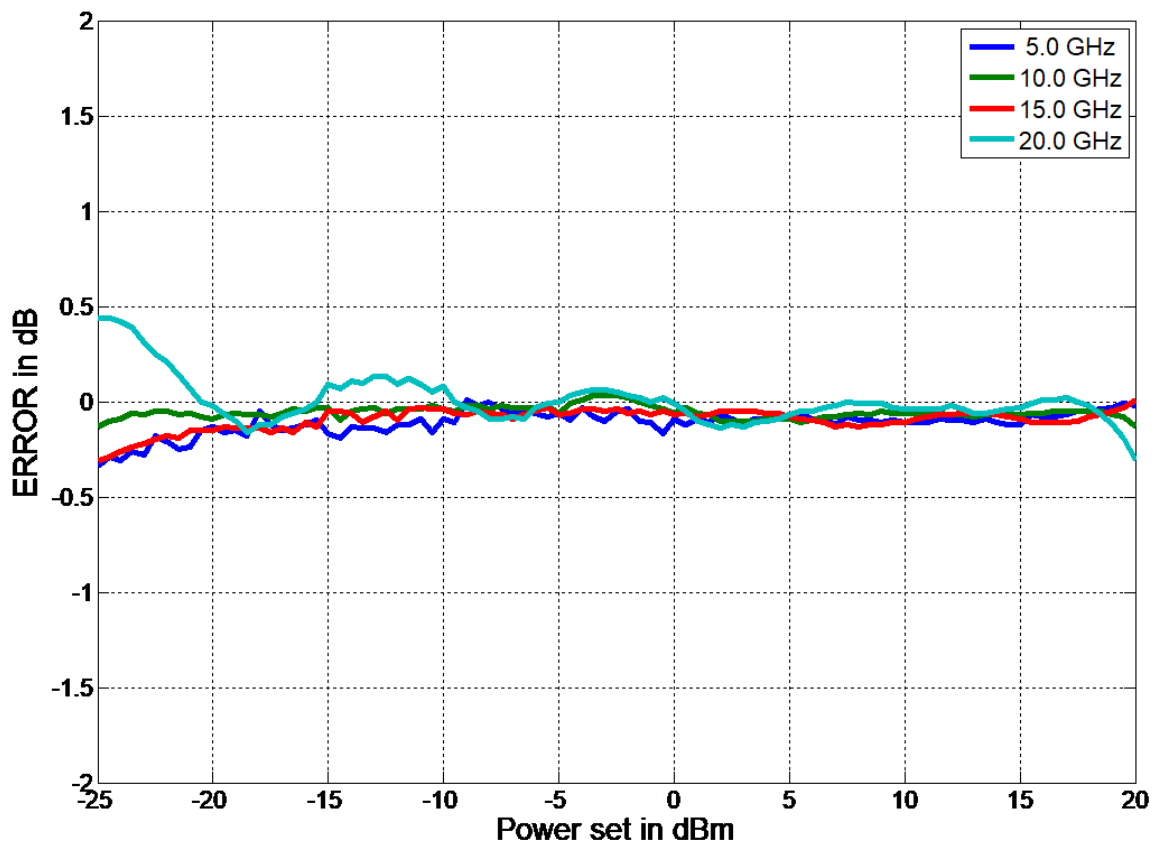
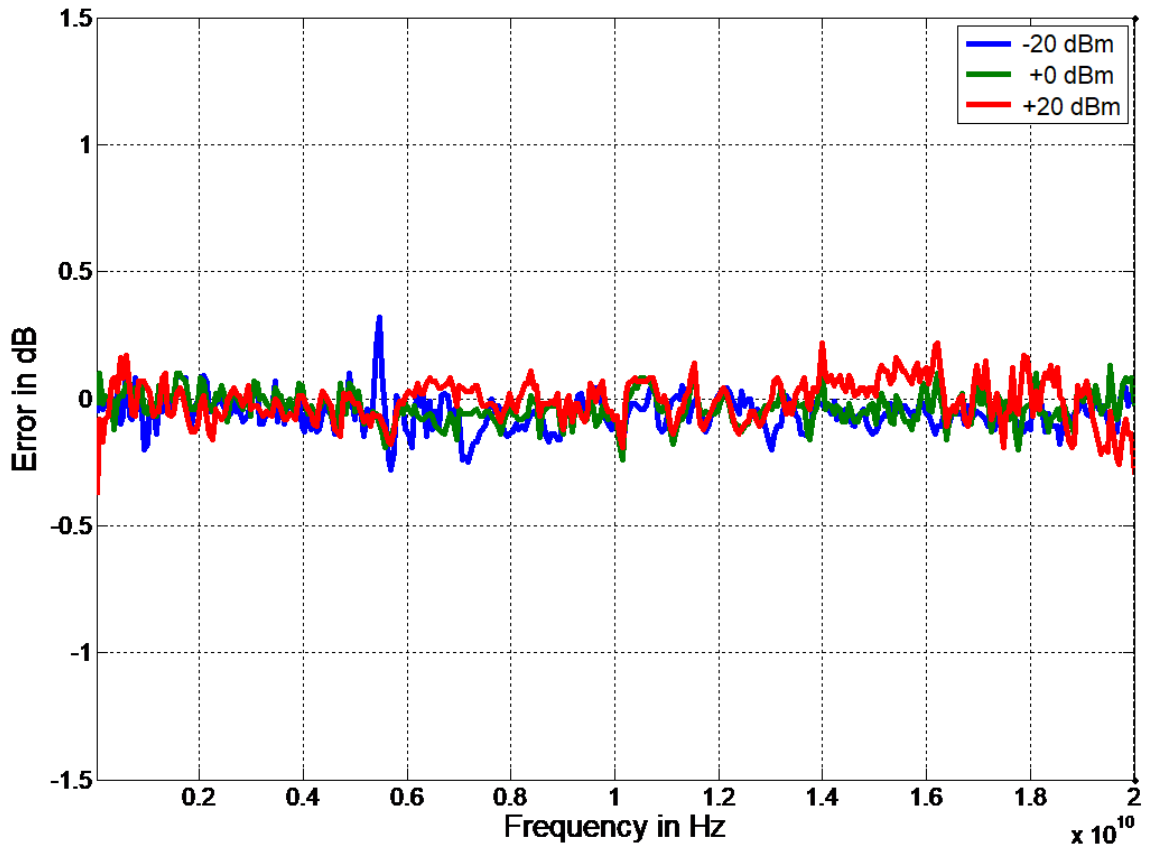

 Typical Maximum Output Power (standard)

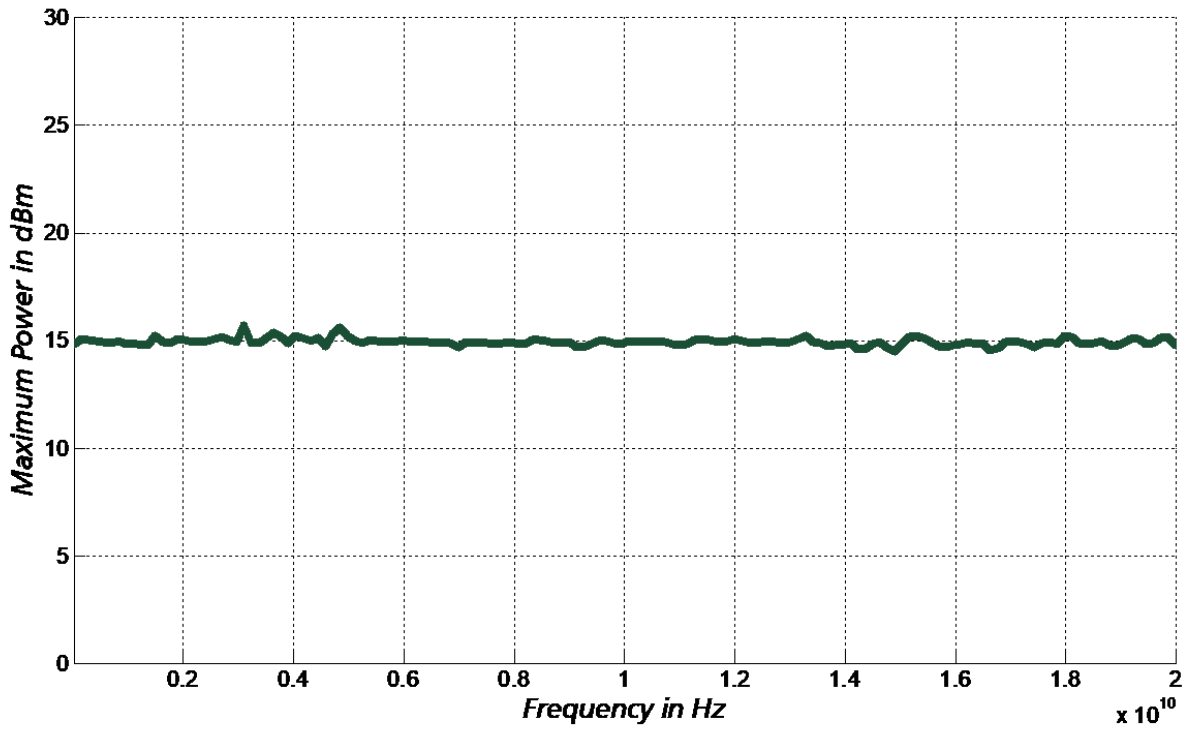

 Typical Maximum Output Power (option HP)

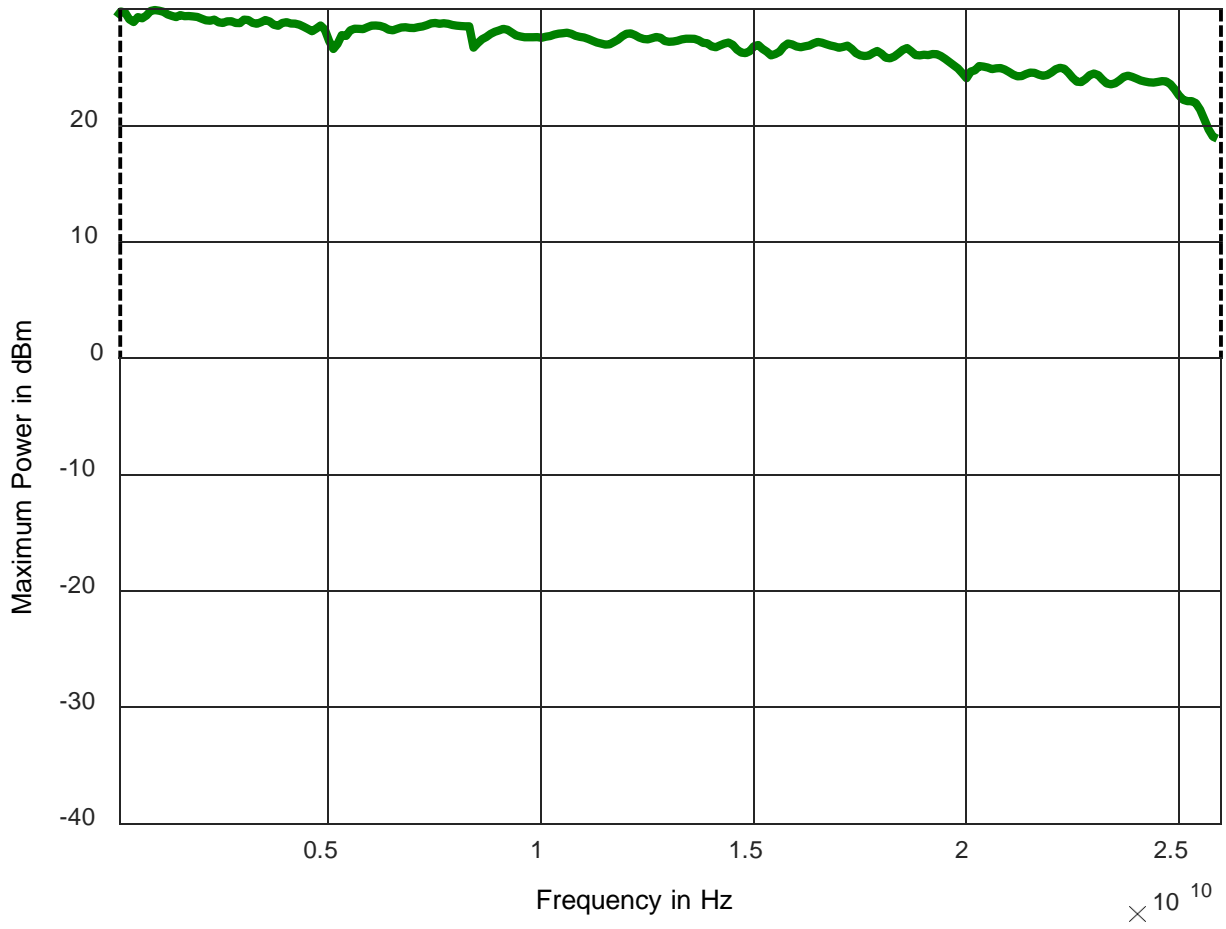

Typical Maximum Output Power (options PE3 and HP)

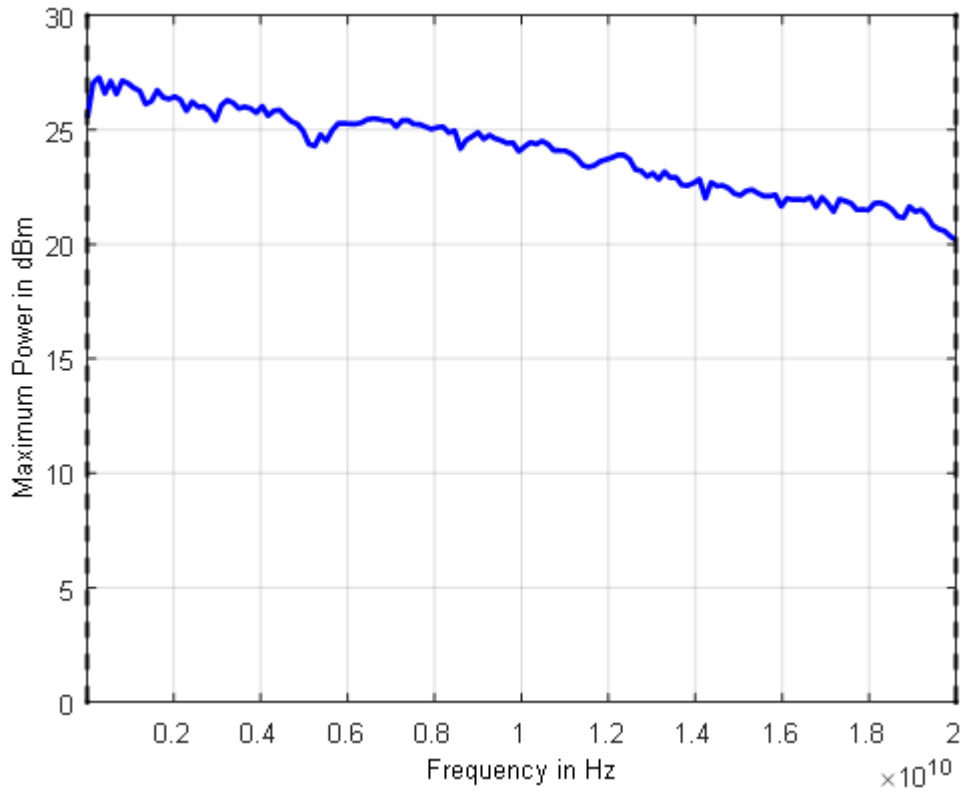

Typical Maximum Output Power from 9 kHz to 1 MHz (options 9k)

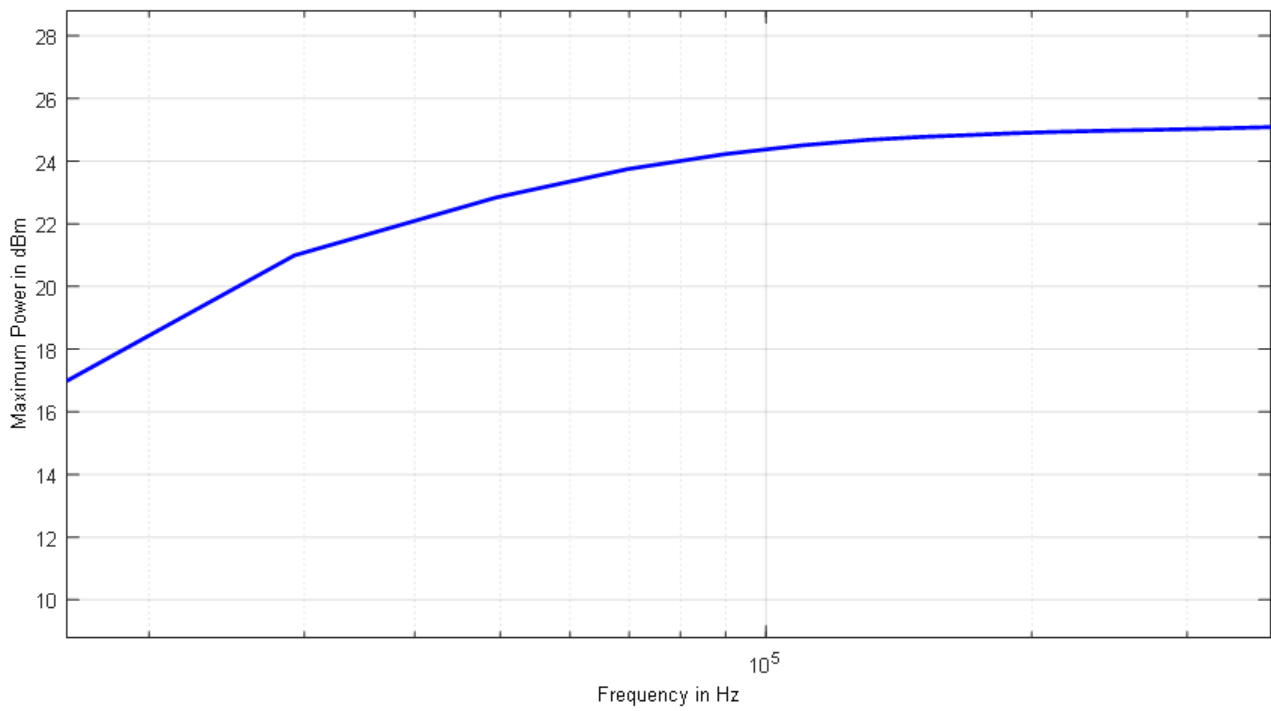

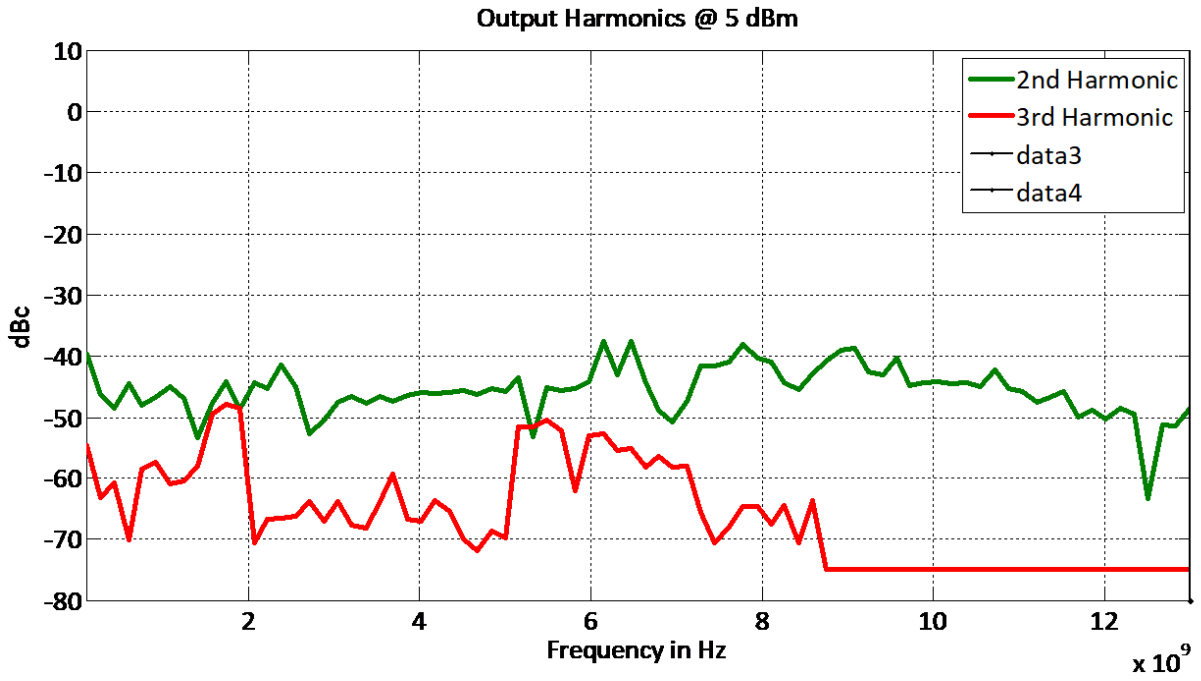

 Typical VSWR (RFSG20G)

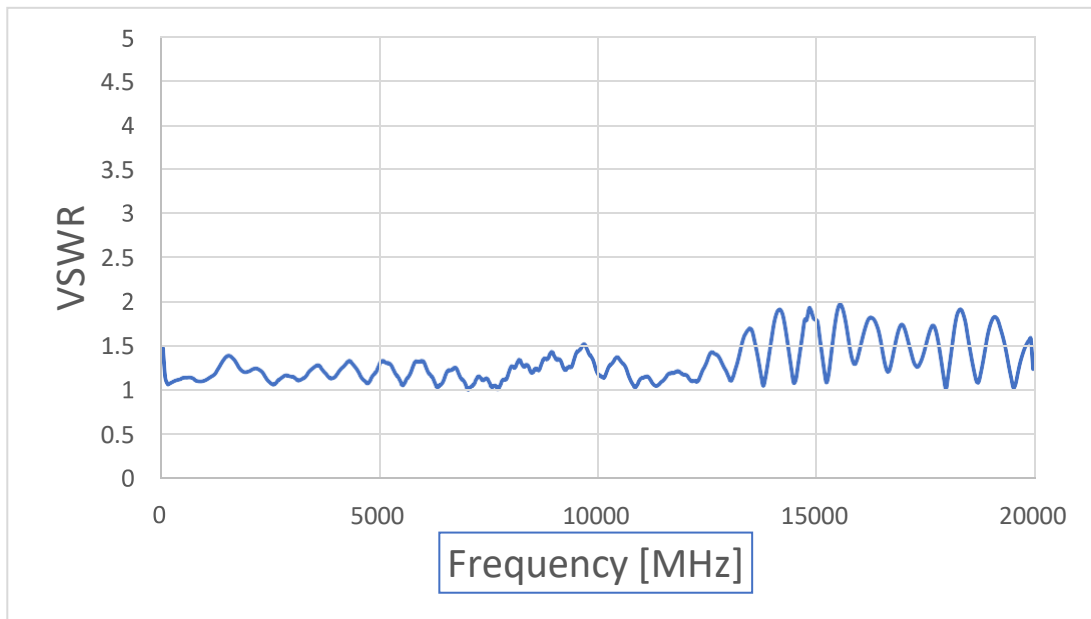

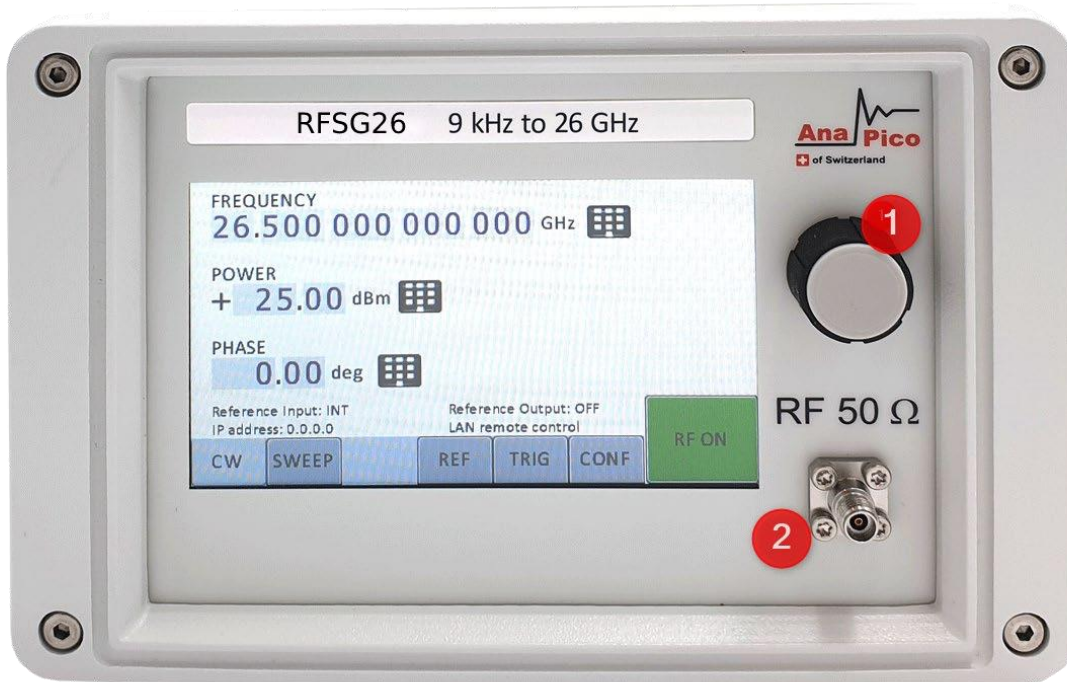

1. **Rotary Button** The rotary button is used to change the value selected on the screen.
2. **RF 50 Ω connector** This female N- type respectively SMA connector provides the output for generator signals. The impedance is 50 ohm. The reverse power damage level is +30 dBm maximum. The maximum allowed DC level is +/- 10 V. Please check the data sheets for more details.

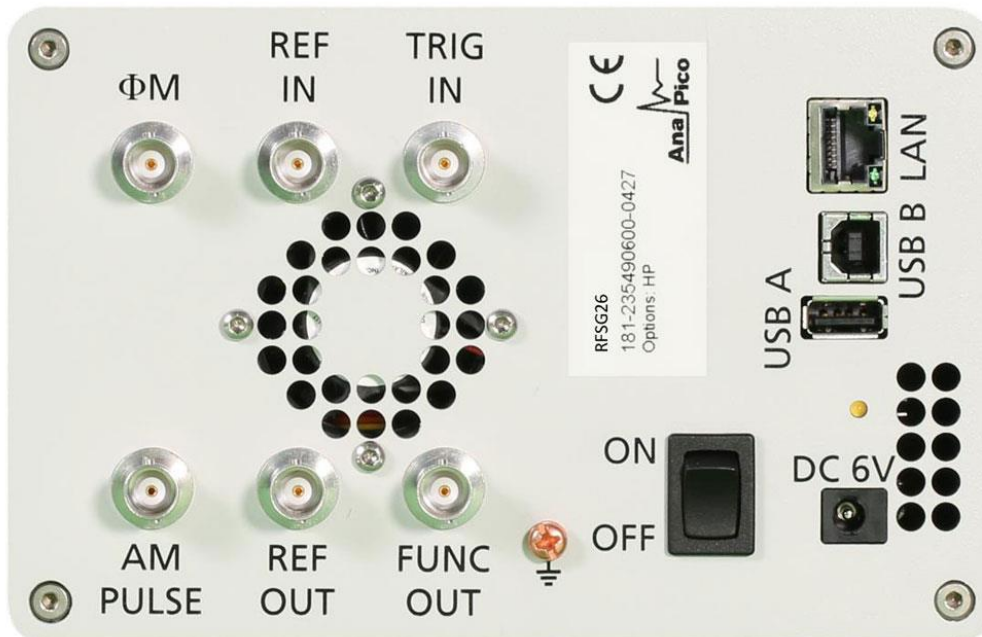

Rear



1. **Φ M** This BNC female Connector is the input for FM and PM.
2. **REF IN** This BNC female Connector is the input for the reference signal.
3. **TRIG IN** This BNC female Connector is the trigger input.
4. **USB B** The USB B connector is used to connect the device to a computer.
5. **LAN** The LAN connector is used to connect the device to a network.
6. **Battery LED** In case the device has a rechargeable battery, this LED indicates whether the battery is charged or not.
7. **Fan Holes** The air intake of the fan.
8. **Power Supply** Connect the Anapico power adaptor to this connector to supply the device with energy.
9. **ON/OFF Switch** Turns the device on or off.
10. **Ground Screw**
11. **FUNC OUT** This BNC female Connector is the output for the function signal.
12. **REF OUT** This BNC female Connector is the output for the reference signal.
13. **AM PULSE** This BNC female Connector is the input for the AM and the PULSE Modulation signal.
14. **Fan Holes** The holes by which the air is extruded.

ORDERING INFORMATION

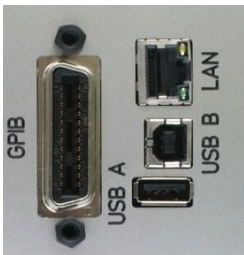

HOST MODEL	PRODUCT	DESCRIPTION
RFSG12G	RFSG12G	12 GHz MW Signal Generator
RFSG20G	RFSG20G	20 GHz MW Signal Generator
RFSG26G	RFSG26G	26 GHz MW Signal Generator
RFSG12G/20G	Option 9K	Frequency range extension to 9 kHz
RFSG12G/20G	Option PE3	Mechanical step attenuator (12 & 20 GHz version)
RFSG26G	Option PE3	Mechanical step attenuator (26 GHz version)
RFSGxx	Option HP	Higher output power
RFSGxx	Option FS	Ultra-fast switching speed
RFSGxx	Option B3*	Internal rechargeable battery module
RFSGxx	Option GPIB*	GPIB interface 
RFSGxx	Option 1URM	19" 1HU rack-mount module  Dimensions 42 mm H x 426 mm W x 460 mm L [1.7 in H x 16.8 in W x 18.1 in L]
RFSGxx	Option LH	Desktop housing with color touch display  Dimensions with handle: 137 mm H x 376 mm W x 402.25 mm L [5.39 in H x 14.81 in W x 15.84 in L], 5.5 kg Dimensions without handle: 137 mm H x 335 mm W x 340 mm L [5.39 in H x 13.19 in W x 13.39 in L]
RFSGxx	Option REAR	Move output to rear panel
RFSG20G /26G	Option NM	Remove modulation
RFSGxx	Option OEM	OEM package
RFSGxx	Option WE	One year warranty extension (standard: 2 years)
RFSGxx	Option ReCal	Recalibration with test data (recommended: 2 years interval)

GENERAL CHARACTERISTICS

Remote programming interfaces

Ethernet 100BaseT LAN interface,
USB 2.0 host & device
GPIB (IEEE-488.2,1987) with listen and talk (optional)
Control language SCPI Version 1999.0

Power requirements 6.25 ± 0.2 VDC; 20 W maximum

Mains adapter supplied: 100-240 VAC in/ 6 V 6.0 A DC out

Environmental (Levels similar to MIL-PRF-28800F Class 3/4)

Environmental stress Samples of this product have been type tested to be robust against the environmental stresses of storage, transportation, and end-use; those stresses to temperature, humidity, shock, vibration, altitude, and power line conditions.

Operating temperature range 0 to 40 °C

Storage temperature range -40 to 70 °C

Operating and storage altitude up to 15,000 feet (4600 m)



EMC complies and EMC regulations and directives for emission and immunity to interference (EN 61326-1 Industrial, EN/IEC 61326-2-1)

Safety complies with applicable Safety regulation in line with IEC/EN 61010-1

Weight ≤ 2.5 kg (6 lbs) net, ≤ 4 kg (8 lb.) shipping

Dimensions

116.9 mm H x 173.6 mm W x 261.7 mm L (incl. connectors)
[4.60 in H x 6.83 in W x 10.30 in L]

Recommended calibration cycle 24 months